

Hitachi Scanning Electron Microscope
SU3800 SU3900

HITACHI
Inspire the Next

SU3800 SU3900

SCANNING ELECTRON
MICROSCOPE



Science for
a better tomorrow

Performance & Power in a Flexible Platform

Hitachi High-Technologies' scanning electron microscopes SU3800/SU3900 deliver both operability and expandability.

The operator can automate many operations and efficiently utilize their high performance.

The SU3900 is equipped with a large multipurpose specimen chamber to accommodate observation of large samples.

SU3800

Flagship X :
Medium Specimen Chamber Model



High Efficacy & Flexibility

Adaptable graphical user interface accommodates multiple applications and user-experience levels. Fully integrated wide-angle camera-navigation system, SEM MAP, allows for real time tracking. With all new functions, obtain the desired results faster and easier.

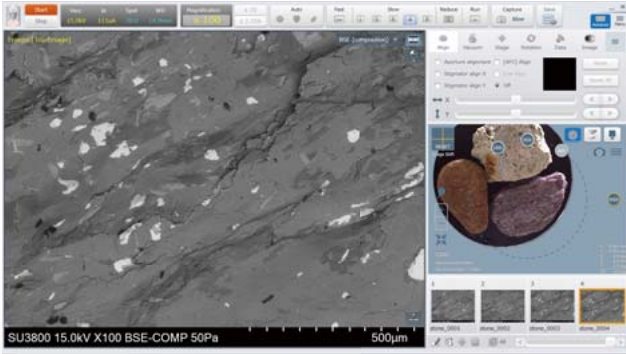

Many types of accessories can be mounted on any of the 20 ports on the innovative SU3900 specimen chamber. Bulk samples of 200 mm dia. (SU3800) and 300 mm dia. (SU3900) can be accommodated.



*optional

SU3900

Flagship XL:
Extra Large Specimen Chamber Model



Including options

Versatile Functions from Sample Setting

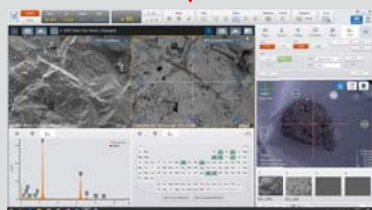
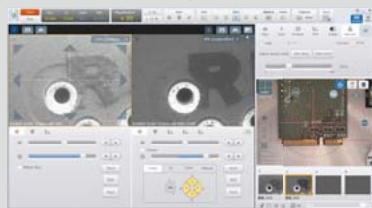
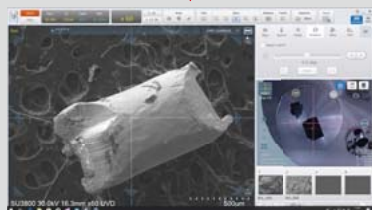
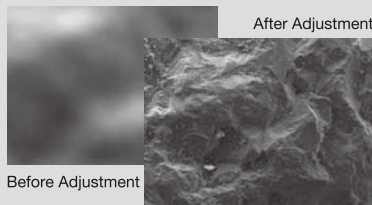
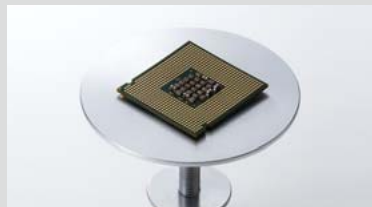

Safe Specimen Exchange

- ▶ The specimen exchange sequence prevents potential damage to the system or the sample.

Automatic Adjustments

- ▶ Quick and reliable auto functions make observation easier than ever.

Wide-Area Camera Navi*

- ▶ Expanded navigation across the entire observable area of the sample.

SEM MAP

- ▶ Real-time tracking and optical correlation system to support navigation.

Analysis Solutions

- ▶ Various functions and analytical packages, such as EDS*, are unified with a single-user interface.

Report Creator

- ▶ SEM/EDS/SEM MAP images can be arranged in customizable templates and output in various formats.

Multipurpose

- ▶ Equipped with a large multifaceted specimen chamber, microanalysis, in-situ analysis, and more.

to Analysis

Multiple Modes of Operation

Features a graphical user interface offering easy operation and flexibility by:

- Ability to control stage navigation and observation conditions via mouse
- Using Touchscreen and/or control panel
- Large main window at 1,280 x 960 pixels
- Simultaneous display for different signal types



Mouse Control Functions

Rapid Image Shift Movement (RISM) + ZOOM

Click to center a feature anywhere on a live image. Draw a box over any region on a live image to center and magnify the area of interest.



Click to center



Select an area to magnify

Simultaneous display of signals SE, BSE, UVD*, EDS, SEM MAP

Display and capture any signal within the user interface.

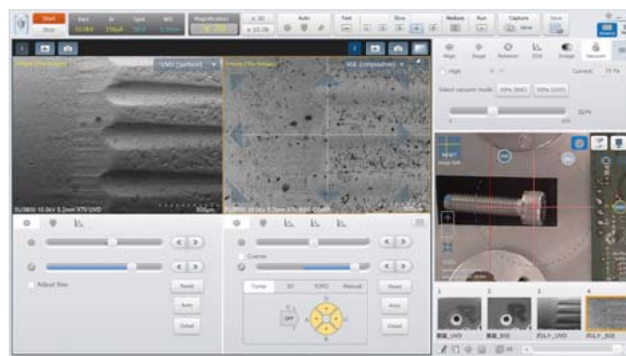

Optimized Beam Brightness

Continuous beam brightness function constantly controls the emission current across the entire accelerating-voltage range, enabling images with high S/N to be acquired even under low accelerating voltage conditions. A wide range of high-resolution observations and surface observations using low accelerating voltage are supported as well.

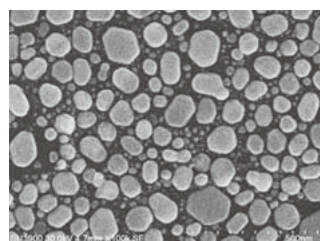
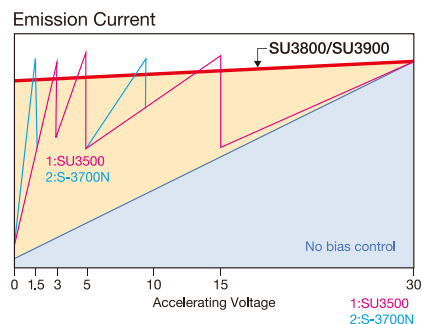

High-resolution SE image
Sample: Gold PVD particles



Low accelerating voltage SE image
Sample: CFRP

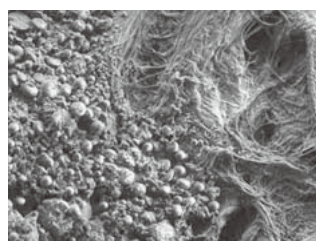

UVD image*
Sample: Painted film

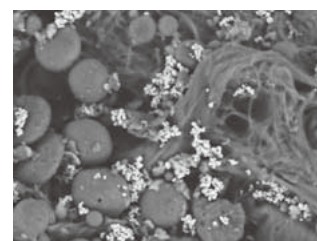

Low vacuum BSE image
Sample: Painted film

Evolution of the Market – Improved Auto for Operators of Any Skill Level

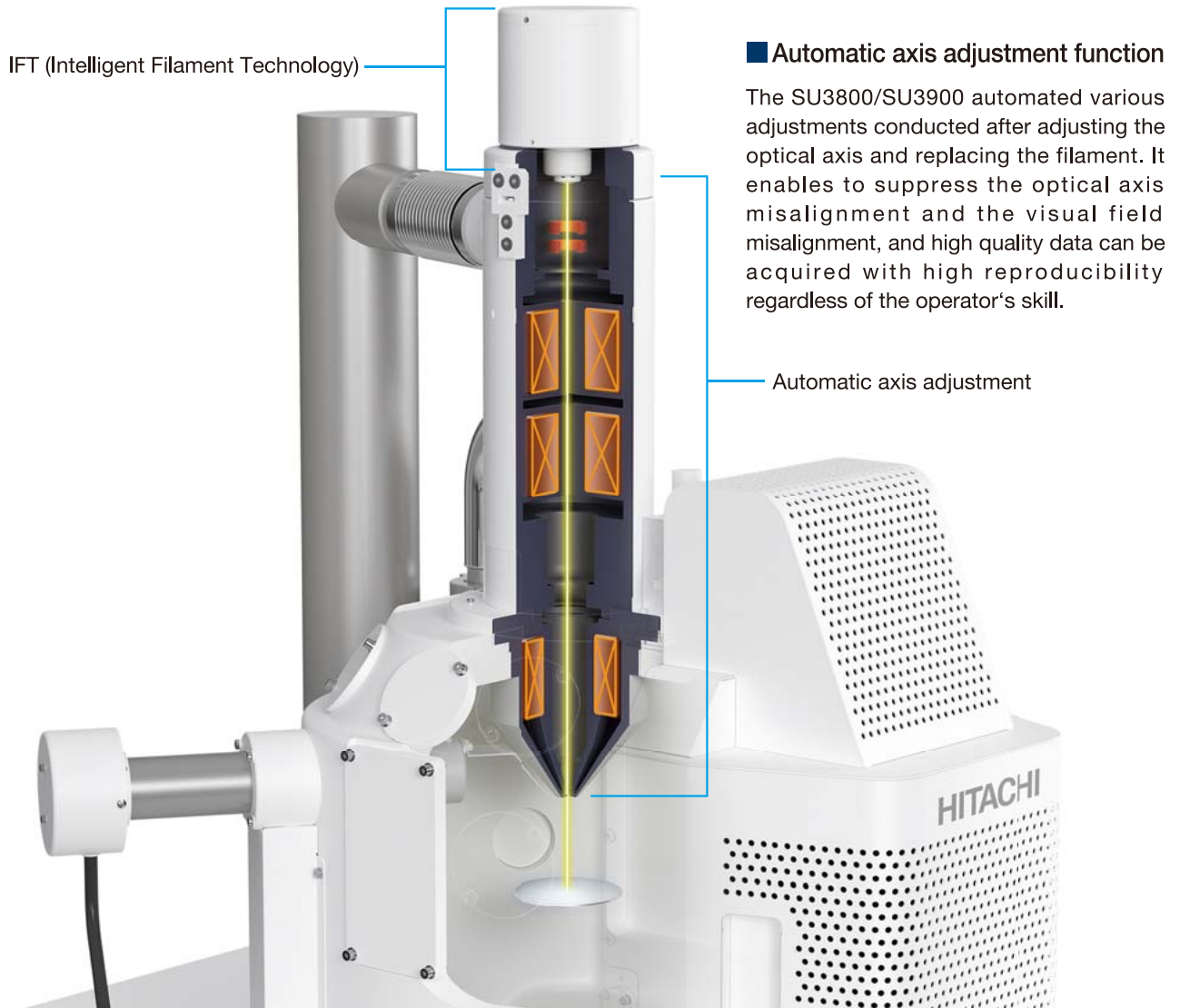

Auto Start Function

The SU3800/SU3900 enhanced the auto adjustment function of electron optical system and detection system. After sample setting is complete, various image adjustments [AFS/ABCC/AFC/ASC] are automated, such that sample images can be acquired immediately after starting observation.

Automated Functions:

- AFS = Filament Saturation
- ABCC = Brightness Contrast Control
- AFC = Focus Control
- ASC = Stigma Control

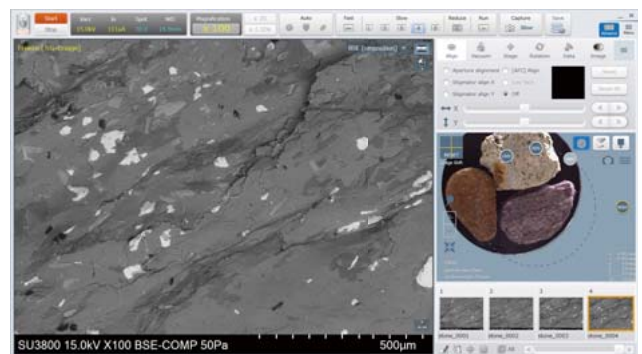

Automatic Functions

Improved Auto Algorithms – 3X Faster

Thanks to the high-speed auto functions based on new design algorithms, the time to execute image adjustment auto functions is 3X faster as compared with the previous model. High-quality data acquisition is faster than ever!

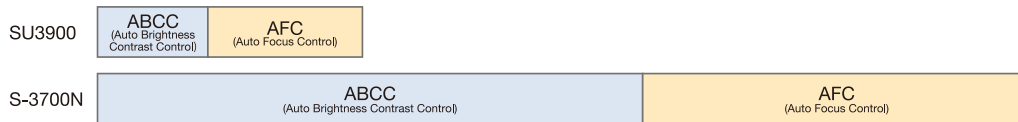

Improved Auto Focus Function

The improved auto-focus algorithm now makes it even easier to quickly acquire high-quality images, especially for planar samples.

▼ Before Adjustment

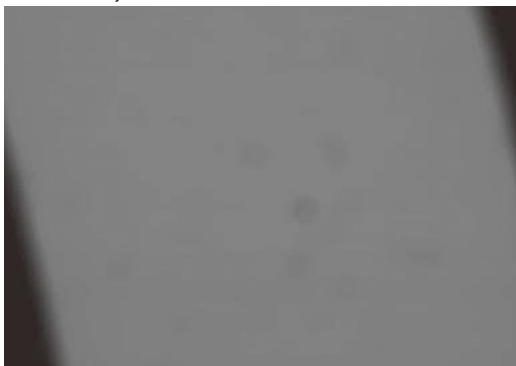

▼ After Adjustment

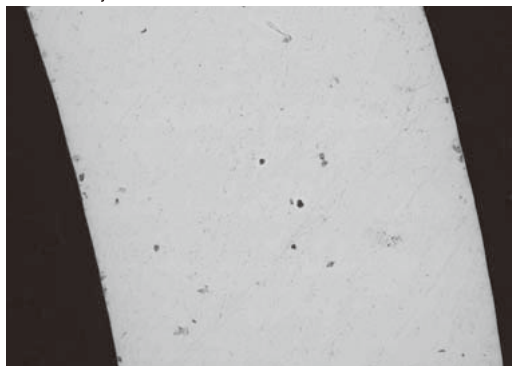

Proprietary Filament Control Delivers Consistently Optimized Performance

Features of our Proprietary Intelligent Filament Technology (IFT):

- Automatic monitoring and control of filament condition ensure long filament life.
- Real-time monitoring and feedback display remaining filament life.

With this function, The operator can use the device with confidence even for long-term continuous observation, such as particle analysis.

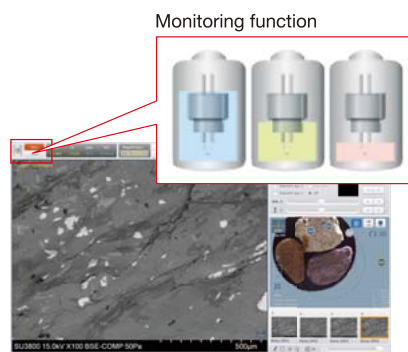
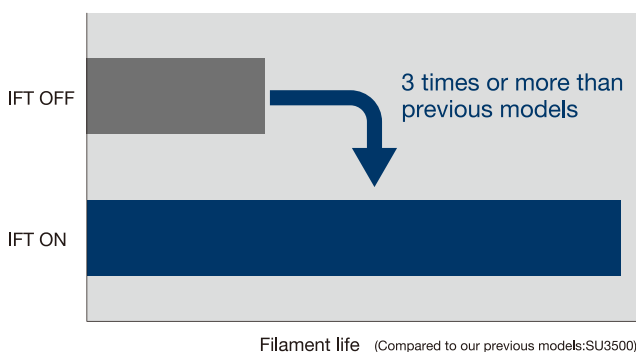

High Sensitivity Detectors Support All Ob

The SU3800/SU3900 extend the vacuum range and detector sensitivity to address diverse observation needs. The Ultra Variable-Pressure Detector (UVD)* can be mounted to supplement a secondary electron detector (SED) along with a high- sensitivity semiconductor backscattered electron detector (BSED), to cover analyses in any vacuum mode. The UVD can acquire topographic information and photonic (cathodoluminescence, CL) information generated by electron beam irradiation.

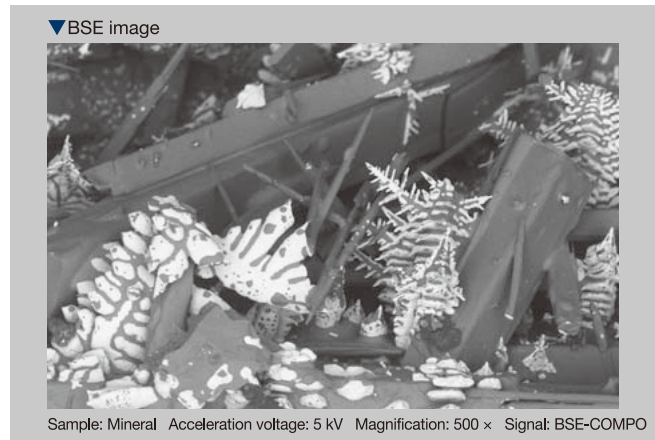
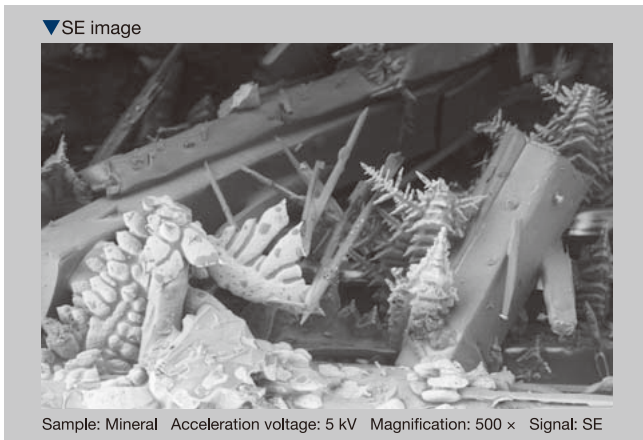
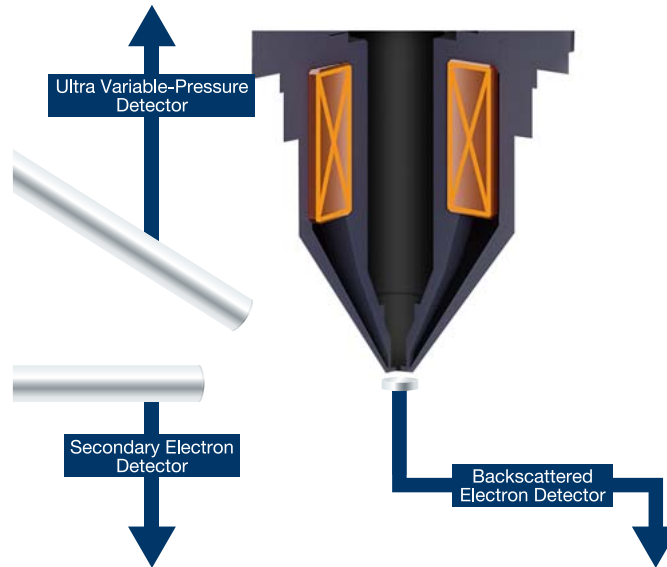
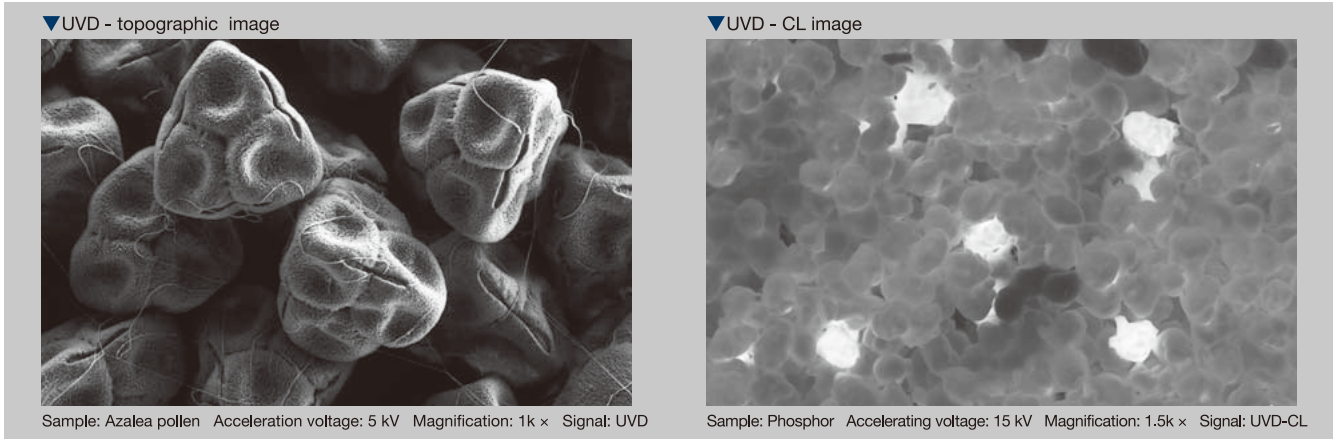

Observation Requirements

CL Observation using UVD*

The SU3800/SU3900 features a high sensitivity UVD. UVD can acquire images and CL information with secondary electron information by detecting the light generated by collisions of secondary electrons and residual gas molecules accelerated by a bias electrode.

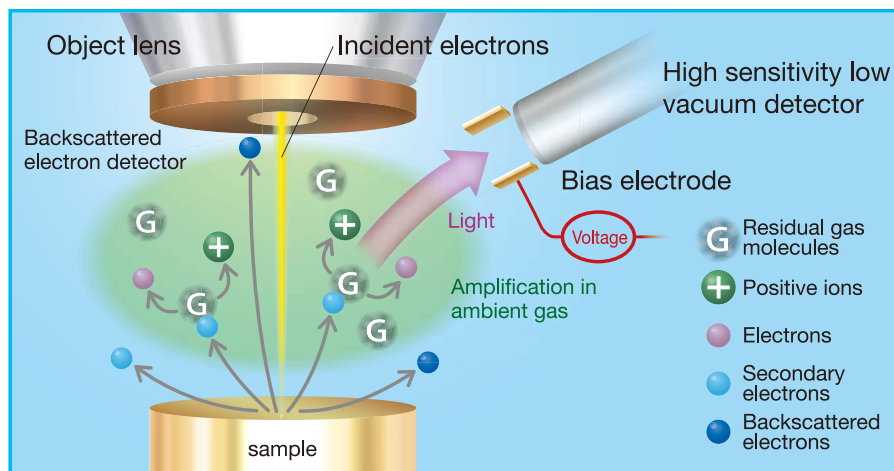

Detection principle of high sensitivity low vacuum detector

▼UVD (topographic image) Sample: Phosphor

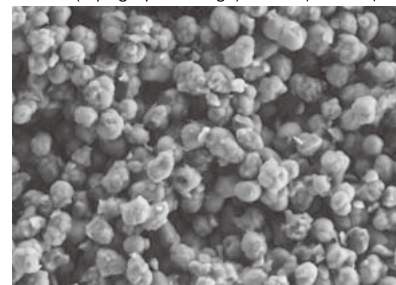

▼UVD (CL image) Sample: Phosphor

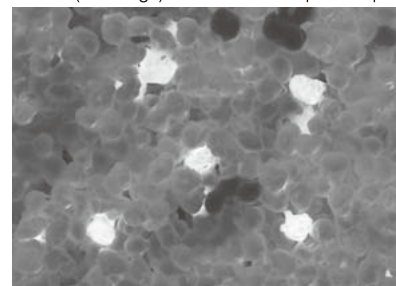

Segmented BSED Allows for Visualizing Composition and Topography

With a 5-segment design, it is possible to observe composition images, 3D images, and topographic images from 4 directions without sample rotation. Due to the design and high sensitivity of the detector, high resolution as well as improved S/N retention imaging is possible.

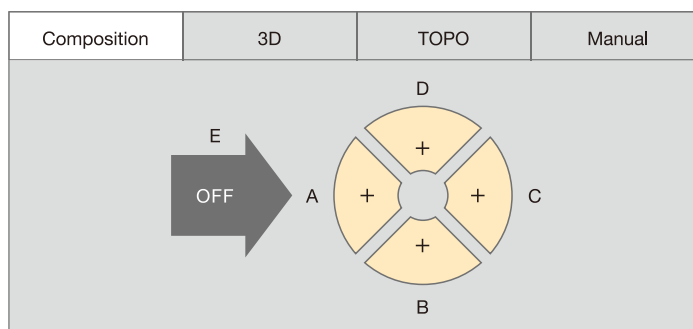

▼Composition image Sample: Iron ore

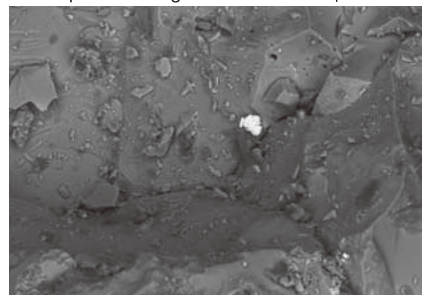

▼3D image Sample: Iron ore

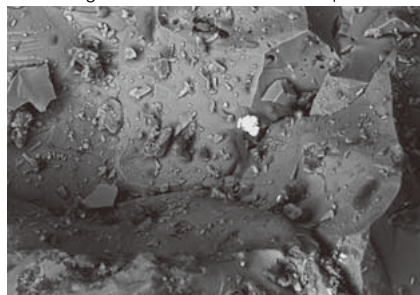

▼Topographic image Sample: Iron ore

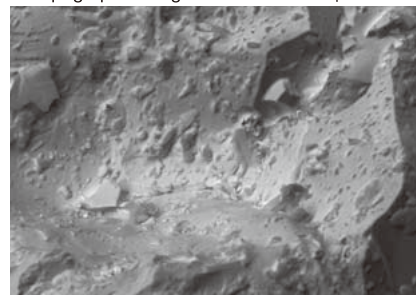

Substantially Larger Specimen Chamber Ac

Robust Stage for Flexibility in Sample Size, Shape, and Weight

The SU3800/SU3900 features a stage that can handle large and heavy samples.

	SU3800	SU3900
Maximum sample size (diameter)	200mm	300mm
Overall area observation range (diameter)	130mm	200mm
Allowable maximum mounting weight	2kg	5kg (without TZR)
Allowable maximum mounting height	80mm	130mm

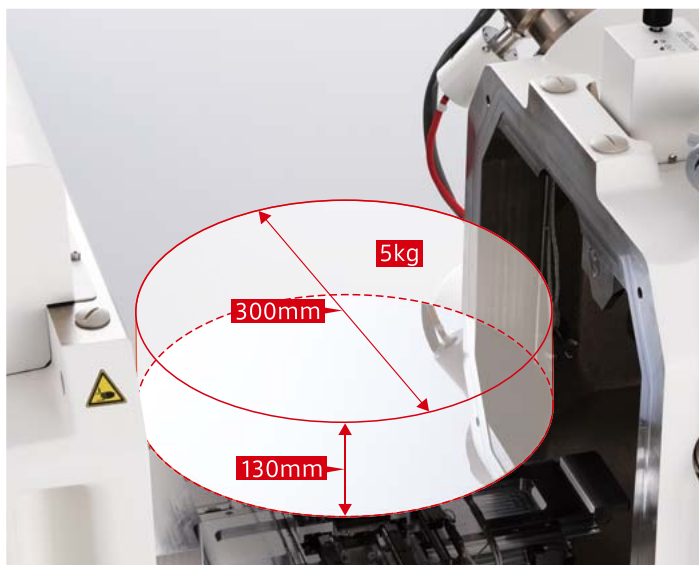

Drill (dia. 130 mm)
Installation diagram

Drill of tip (optimum position of analysis WD=10 mm)

Sample Exchange Sequence

The procedure for exchanging a sample can be performed in the graphic user interface to avoid the risk of damage due to human error, even with irregular or large samples.

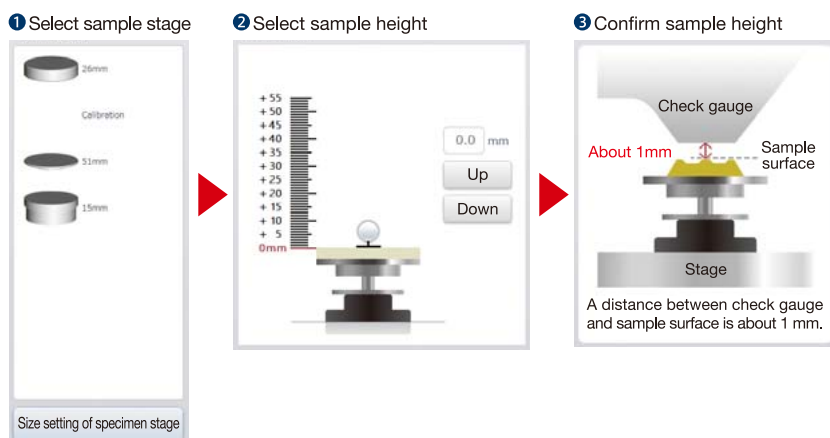

Specimen Exchange Chamber*

Exchange the specimen without venting the specimen chamber, improving throughput.



commodates Oversized and Heavy Samples

The Chamber Scope Enhances the Safety of Stage Movements*

The Chamber Scope is a device for monitoring the inside of the specimen chamber. By using an infrared camera the inside of the specimen chamber can be monitored at the same time as observing an SEM image. It is now possible to magnify the Chamber Scope image and view the sample position more clearly.

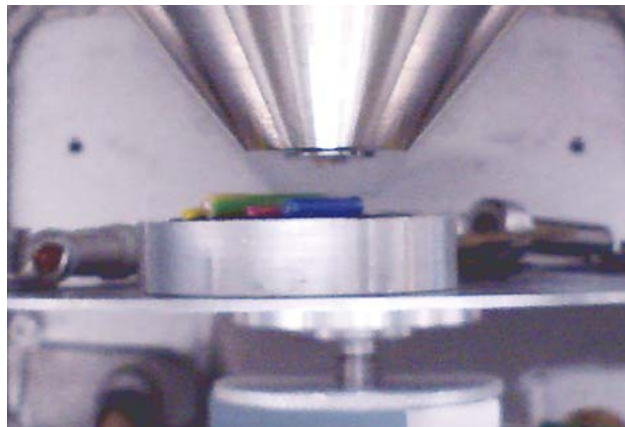

Increase Sample Manipulation with Stage Movement Restriction Cancellation Function*

The SU3800/SU3900 can be configured with Stage Movement Restriction Cancellation Function*, which increases the flexibility of stage movement. The operator can move the stage based on their imaging requirements free of restrictions.

*When in Stage Movement Restriction Cancellation Function, caution and the Chamber Scope must be used in order to ensure safe operation.

Multi Zigzag* Enables Wide-Area Observation Across Multiple Areas

The Zigzag function enables automatically acquire a continuous field of view. The Multi Zigzag Function enables Zigzag settings at multiple locations on the sample stage, enables the acquisition of multiple high-magnification images at user-selectable regions of interest. These images can be montaged to create pixel-dense micrographs by connecting the acquired images with the Viewer Function.

▼ Navigation image of Circuit board

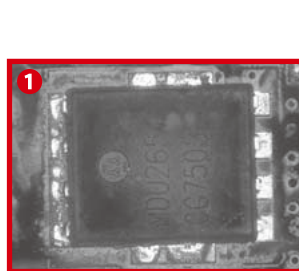
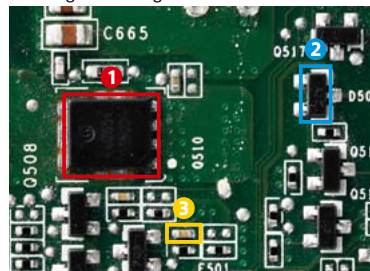

① Observation magnification: 30x
Number of images acquired: 3x3 images

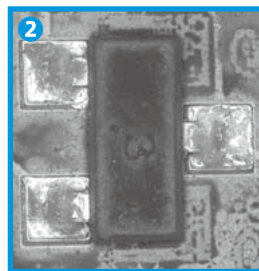

② Observation magnification: 50x
Number of images acquired: 2x3 images



③ Observation magnification: 100x
Number of images acquired: 2x1 images

Increased Viewing Area – SEM MAP Expa

Integrated In-Chamber Camera Display

SEM MAP offers wide-angle camera navigation* within the graphic user interface. By specifying the observation target position on SEM MAP, the operator can move seamlessly to any position within the observable area and switch from a wide field of view color image to a high magnification SEM image by zooming in and out. Any image can be imported and utilize this capability.

1 Start observation

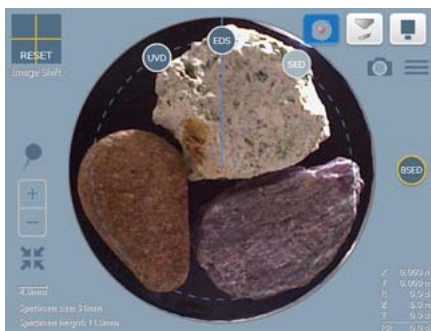

2 Move to your observation area by double-click

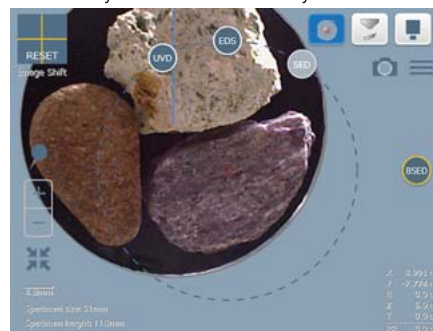

3 Zoom in with digital zoom

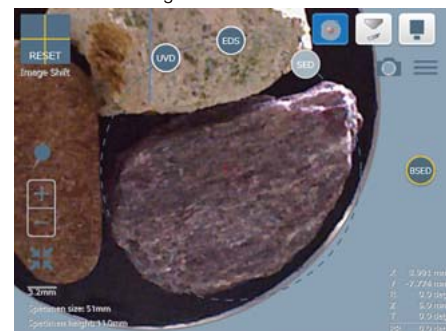

▼ Display the CCD camera images superimposed

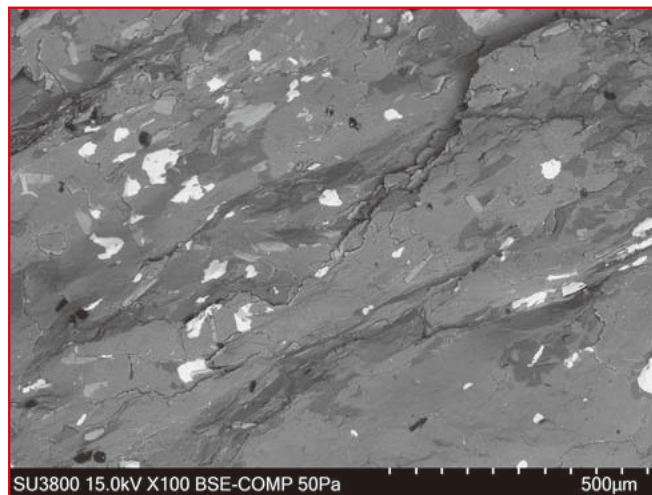

Ends the Boundaries of Sample Navigation

Easily Navigate the Entire Observable Area

Wide-area SEM MAP images are obtained by stitching numerous images. Navigate to any location of the observable areas, 127mm dia. / 200mm dia. (SU3800/SU3900) with a single click. If necessary, the stage will rotate automatically during navigation.

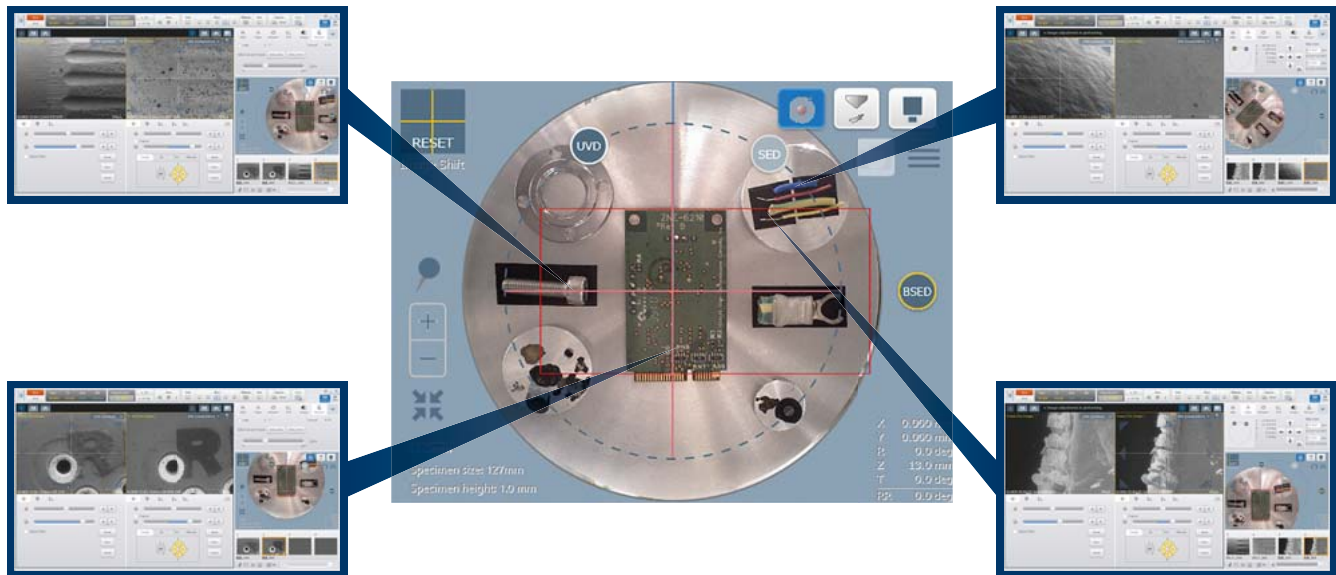

Detector Oriented Rotation

The graphic user interface makes it easy to visually grasp the orientation between the sample and the detectors allowing the operator to seamlessly navigate regions of interest, incorporating rotation. During the observation/analysis of samples with topographic irregularities, rotating the stage and scanning direction while looking at SEM MAP alleviates challenges, such as the influence of shadows.

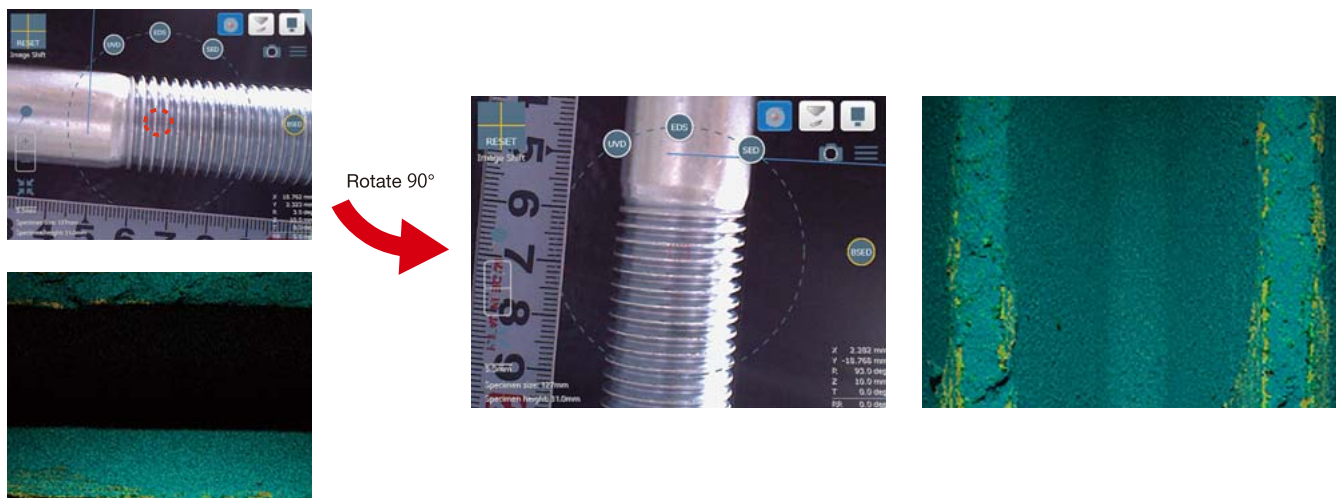

Integrated Solutions for Various Applicati

SEM/EDS Integration System*

The newly developed SEM/EDS integration system* unifies stage location, condition setting, analysis, reports and a series of operations from the SEM graphic user interface of the SU3800/SU3900. Controlling everything from the SEM graphic user interface improves throughput and reduces operator tasks.

*Integration varies with EDS models

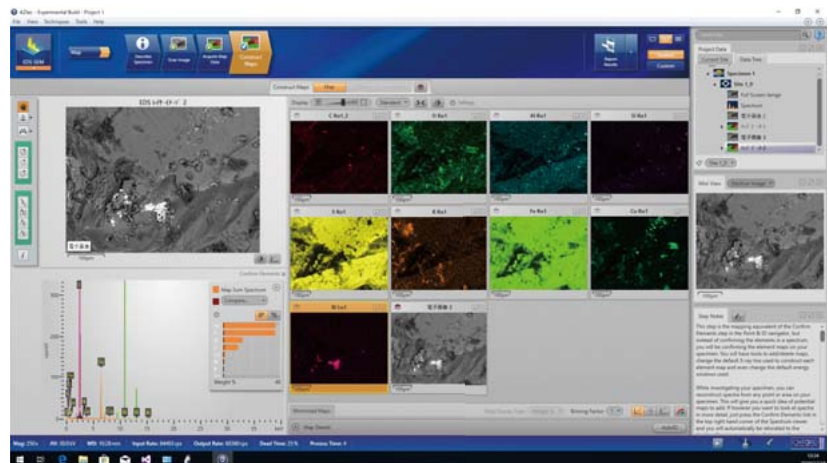
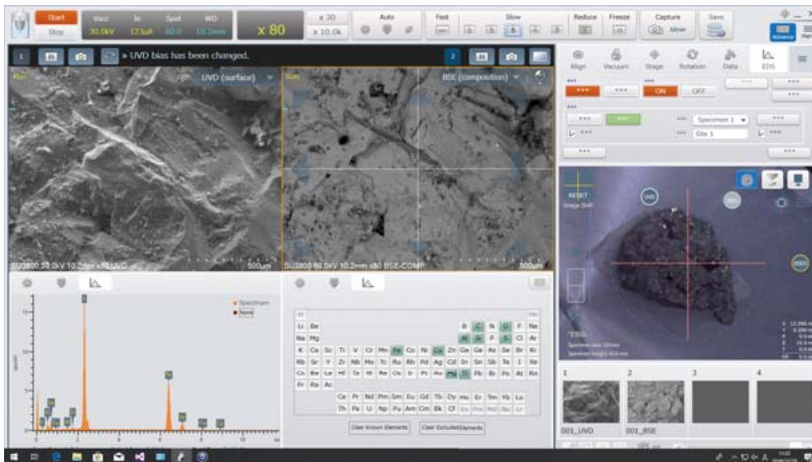

EDS Software Linkage

When performing more sophisticated analyses, the operator can switch to EDS software seamlessly by clicking the icon.

Generating Reports of Acquired Data - Report Creator

Report Creator can export data user-customizable templates, not only for SEM images but also for acquired images such as EDS data and CCD camera images. The created reports can be saved and edited in any Microsoft Office® format.

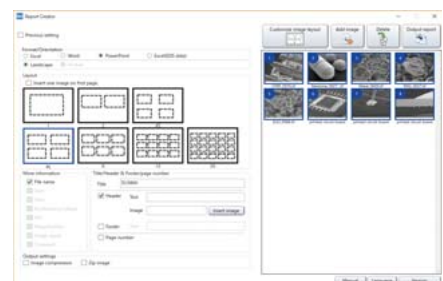

*optional

3D Modeling Software: Hitachi map 3D*

Hitachi map 3D automatically combines four images acquired from different directions using the backscattered electron detector to construct a 3D model. Measurements such as height between two points, volume, and simple surface roughness (area roughness, line roughness, etc.) are possible. Since all backscattered electron data is collected in a single acquisition, it is not necessary to tilt the sample or adjust the field of view.

SEM image (4-direction BSE images)

Combine four SEM images from different directions to convert to 3D model.

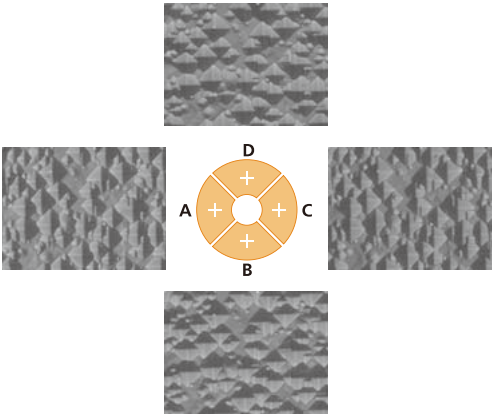

3D image

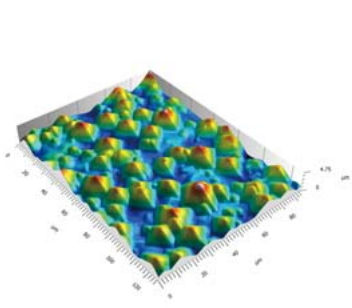

Report output

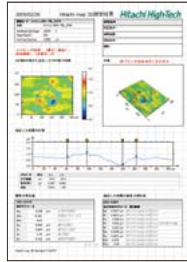

- Accelerating voltage: 5.0k
- Magnification: 2,000x
- Sample: Solar cell

Height and angle measurement of extracted section

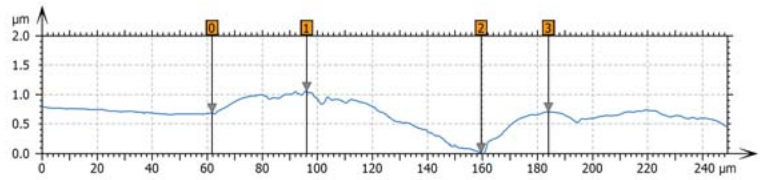
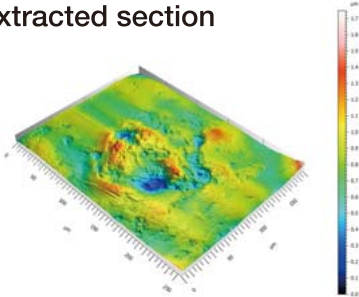
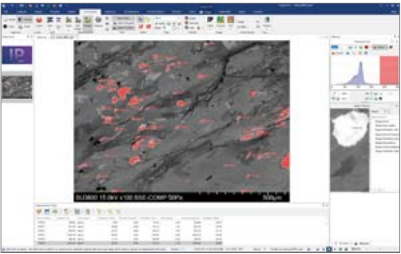
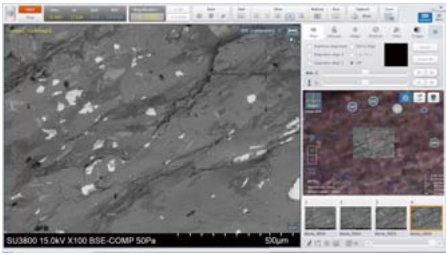

Image Processing, Measurement, and Analysis Software: Image-Pro for Hitachi

The SU3800/SU3900 features IPI, which transfers SEM images to advanced image processing software (Image-Pro® manufactured by Media Cybernetics Inc.). The operator can transfer data from SEM images to sophisticated image analysis software with just one click.



*optional

Options for Additional Imaging and Analysis Needs

STEM Observation

STEM Observation

High quality images can be easily acquired with innovative Hitachi STEM holder

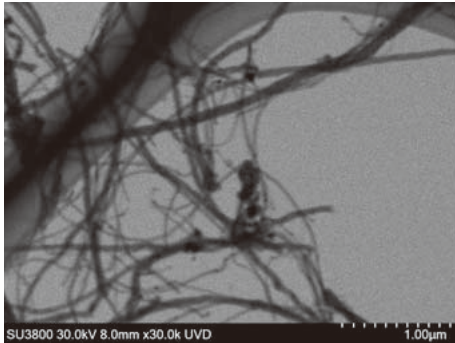

Sample: CNT Accelerating Voltage: 30 kV
Magnification: 30k ×

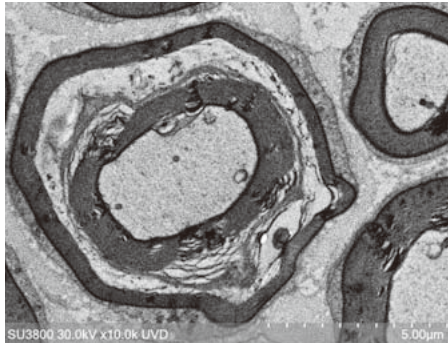

Sample: Sciatic nerve section Accelerating Voltage: 30 kV
Magnification: 30k ×

Heating/Cooling Stages*

Dynamic changes can be observed in-situ by sample heating or cooling.

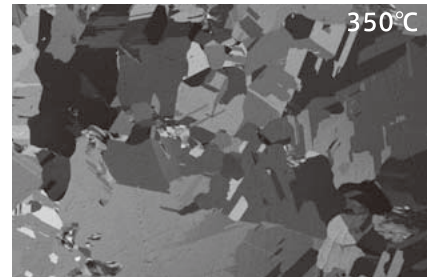
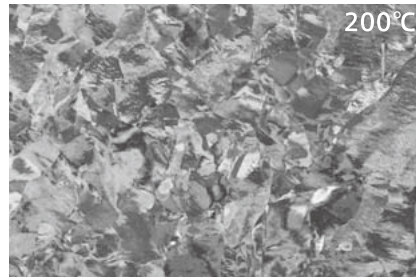
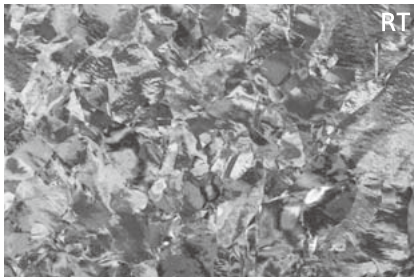

Sample: Copper plate Accelerating Voltage: 30 kV Magnification: 50×

Tensile/Compression Stages*

Physical changes can be observed real-time by applying stress to the sample.

Example: Microtest 300 (manufactured by Gatan)

▼ Before Tensile Test

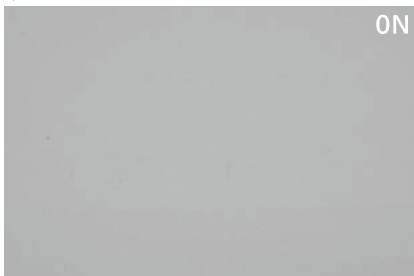

▼ After Tensile Test

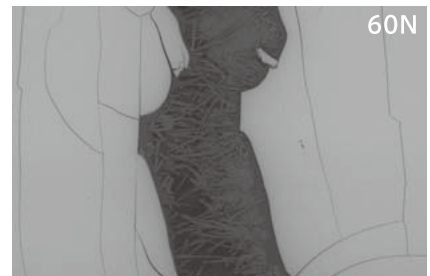
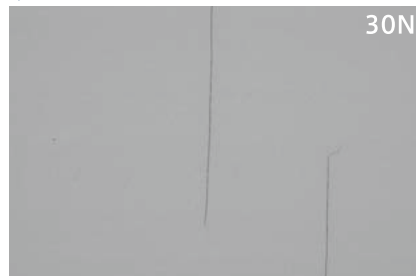

Sample: Coated paper Voltage: Magnification: 50×

Hydrated Samples

SEM observation example of reverse osmosis membrane hydrated by Ionic Liquid

Reverse osmosis (RO) membranes are permeable to water but do not allow impurities such as salts to pass through. RO membranes have a 'skin' layer on the surface, which plays an important role in separating impurities and water. There are numerous protrusions on the surface of this layer, which swell in the hydrated state but can shrink under vacuum (a, b). An ionic liquid solution was applied to a RO membrane and ultimately observed by SEM resulting in the skin layer being maintained in its hydrated state even under high vacuum (c, d).

▼ (a) Skin layer in dry state (5,000×)

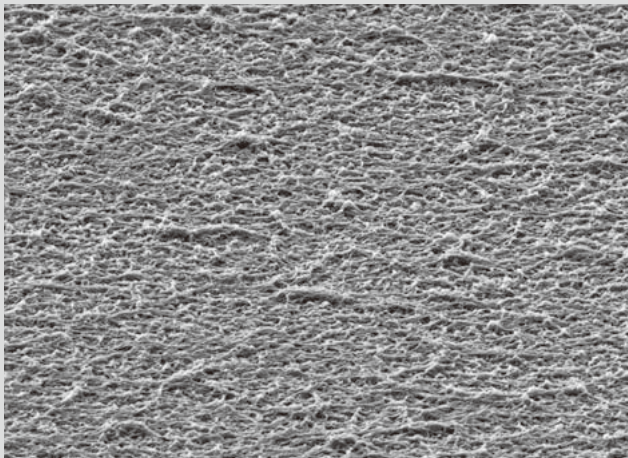

▼ (b) Skin layer in dry state (20,000×)

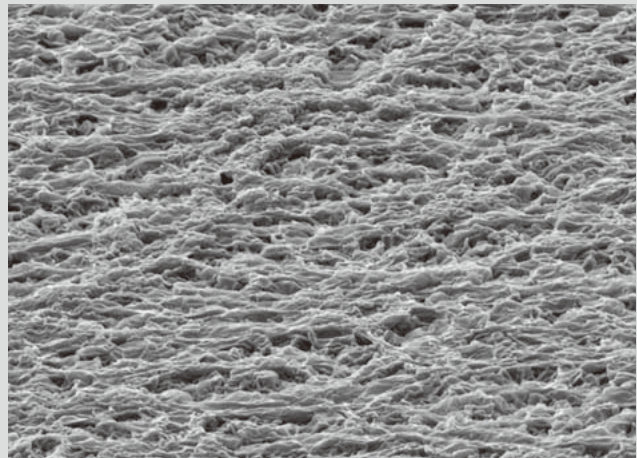

▼ (c) Skin layer in swollen state (5,000×)

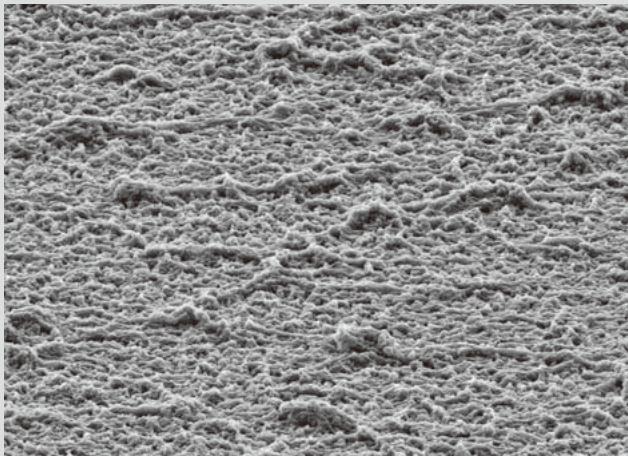

▼ (d) Skin layer in swollen state (20,000×)

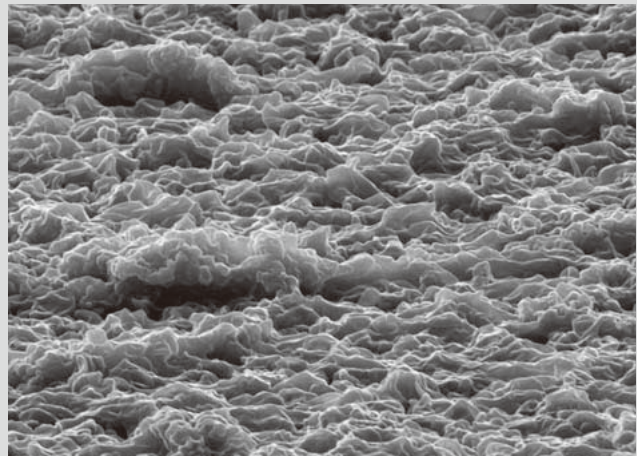

Accelerating Voltage: 7.0kV
Signal: SE
Magnification: (a), (c) 5,000×
Magnification: (b), (d) 20,000×
Stage Tilt: 70°

Electronic Material Applications

Cross-section Observation

Below is an example of a manufactured electronic component prepared by ion milling after mechanical polishing. In (a), the clear grain contrast of the laminated Cu plating layer is observed. In (b), Ag particles distributed in the alloy layer at the solder/Cu plating interface and at the grain boundary of the Pb-free solder are demonstrated.

▼ (a) Cross-section of Cu plating

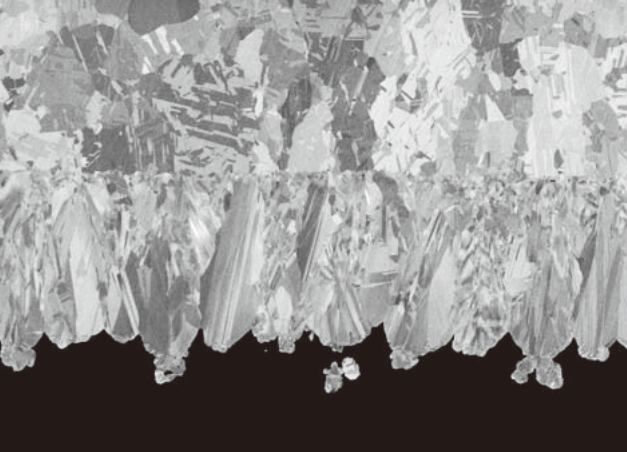

Accelerating Voltage: 5.0 kV
Signal: BSE-COMPO
Magnification: 25,000x

▼ (b) Cross-section of Cu plating/solder interface



Accelerating Voltage: 5.0 kV
Signal: BSE-COMPO
Magnification: 25,000x

Ion milling system accommodates a wide range of applications

Ion milling system ArBlade5000

The SU3800/SU3900 can be paired with a hybrid ion-milling system that can perform sample preparation by cross-section milling or Flatmilling™. In cross-section milling, the sample material that projects beyond the shielding mask is sputtered generating surfaces free of mechanical damage. In Flatmilling™, the ion beam center and the sample rotation center are shifted further away, making it possible to process larger areas that cannot be covered by cross-section milling.



▲ArBlade5000

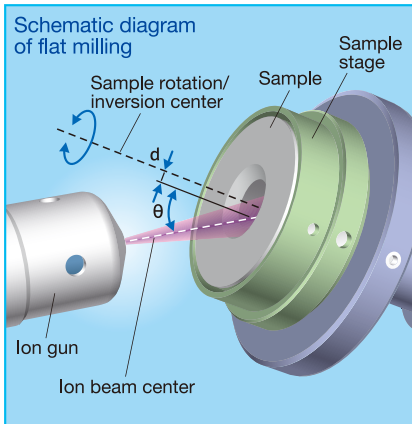
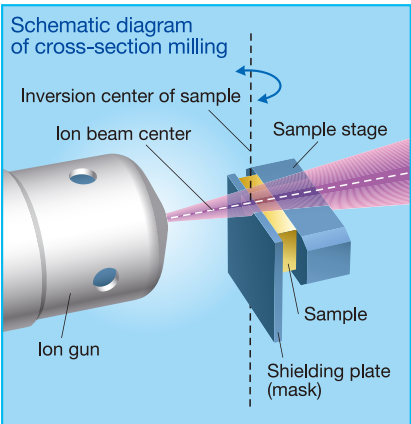

Temperature Sensitive Material Applications

Carbon Fiber Reinforced Polymer (CFRP) Observation

CFRP's are lightweight and high strength composite materials made of plastic reinforced with carbon fiber. In (a), the state of the plastic distribution around the carbon fiber is observed. In (b), cross-section preparation by ion milling confirms that the carbon fiber and the plastic are closely adhered to one another in the longitudinal and lateral faces without gaps.

▼ (a) CFRP surface observation

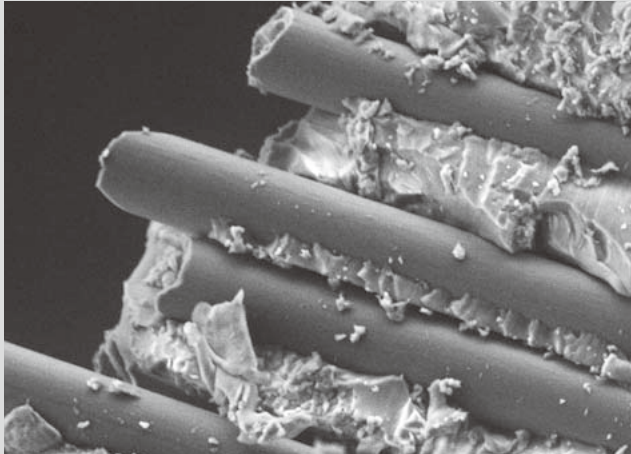

Accelerating Voltage: 7.0 kV
Signal: UVD
Magnification: 25,000x

▼ (b) CFRP cross-section observation

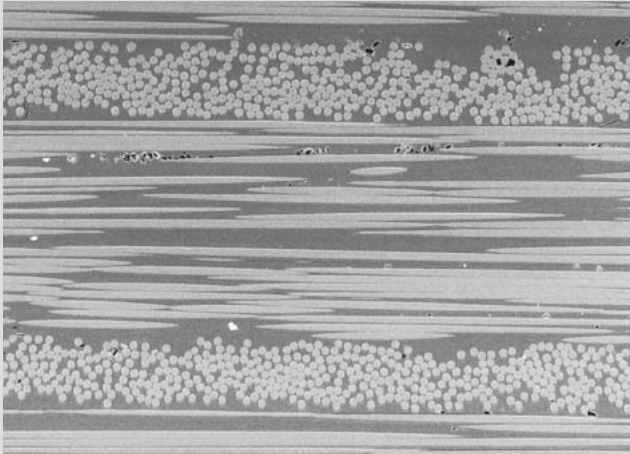

Accelerating Voltage: 7.0 kV
Signal: BSE-COMPO
Magnification: 250x

Holder Compatibility for SEM and Ion Milling

Iterative observation of the processed surface is important to verify a target structure has been revealed. Linkage Adapters and Holders allow the operator to transfer samples between the SU3800/SU3900 and the ion-milling system without removing or realigning the sample.



Observation of mineral/analysis example

The results of observing the same field of view of the zircon crystal are shown below. It is difficult to visualize the gradual concentration difference of zirconium in the BSE image. On the other hand, it can be confirmed that the dark area of the CL image corresponds to the area where the concentration of zirconium is high.

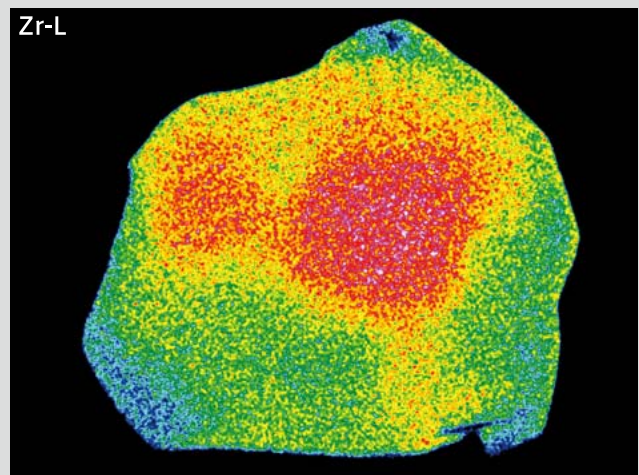
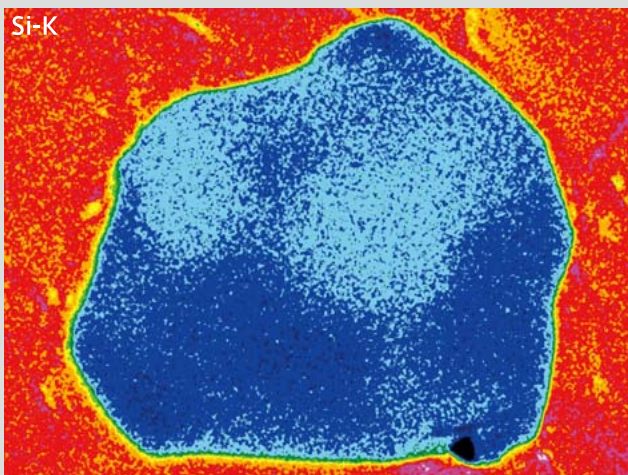
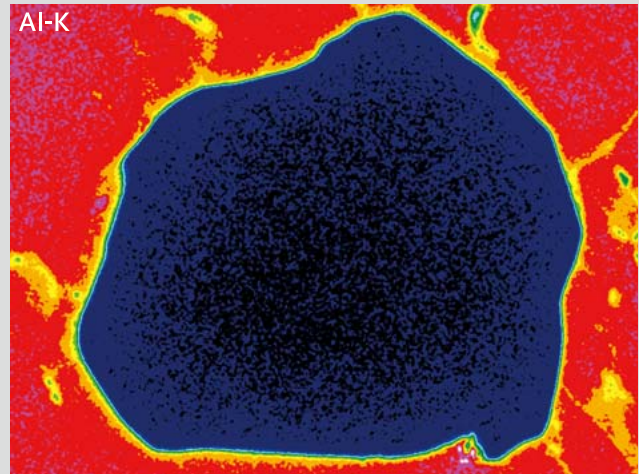
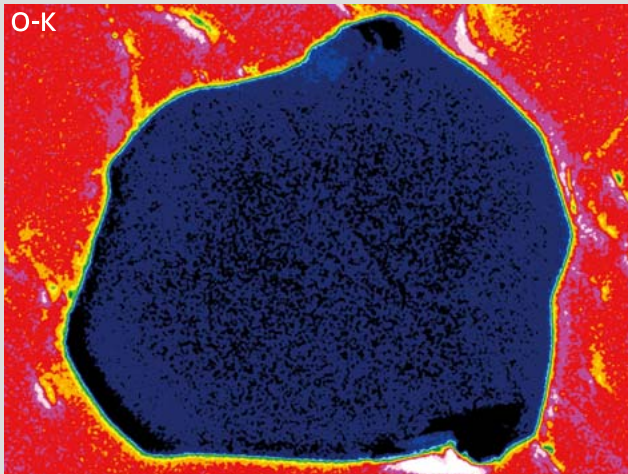
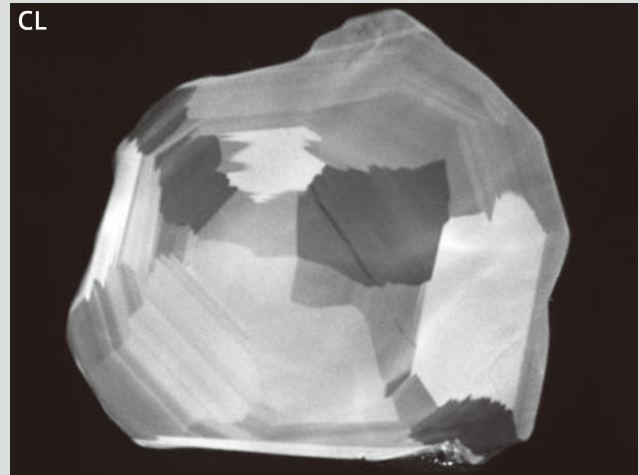

Metallic Materials

▼ Pure titanium

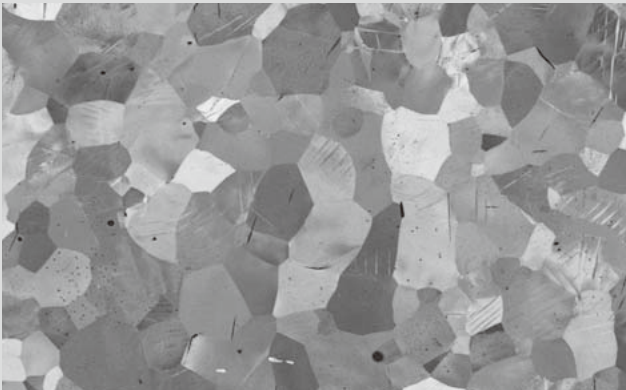

Accelerating Voltage: 5kV
Magnification: 800x

▼ Metal fracture surface

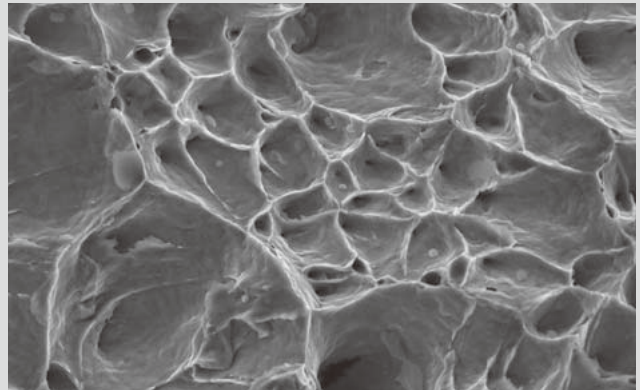

Accelerating Voltage: 7kV
Magnification: 10,000x

Ceramic Materials

▼ Titania particles

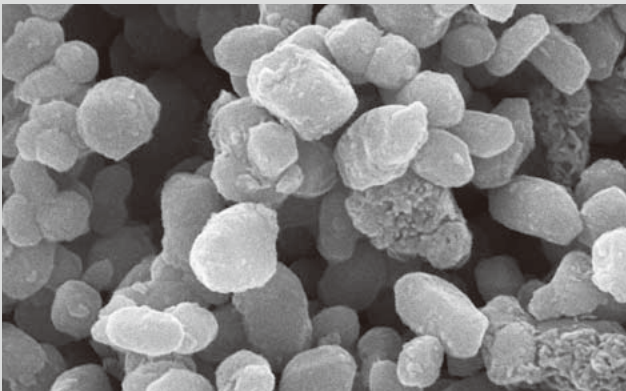

Accelerating Voltage: 8kV
Magnification: 50,000x

▼ Alumina particles

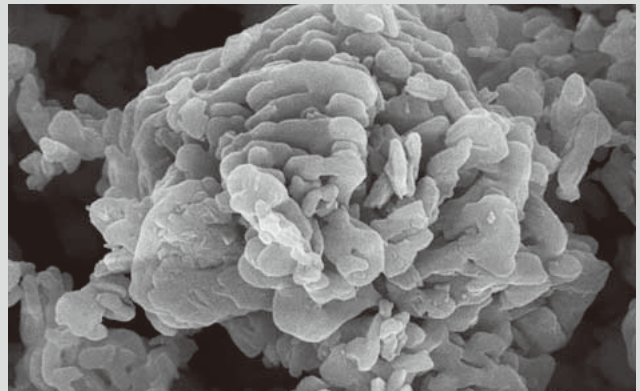

Accelerating Voltage: 8kV
Magnification: 32,000x

Electronic Materials

▼ Wire bonding

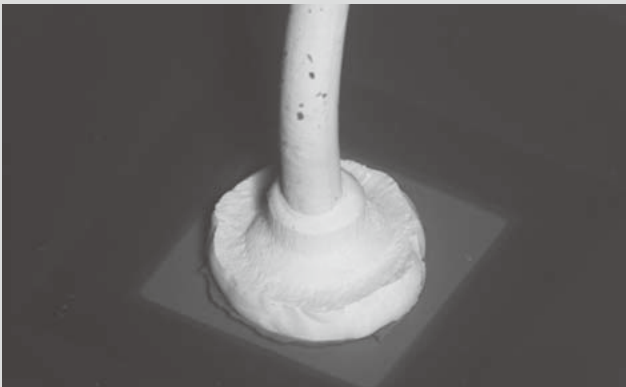

Accelerating Voltage: 15kV
Magnification: 550x

▼ Electronic parts

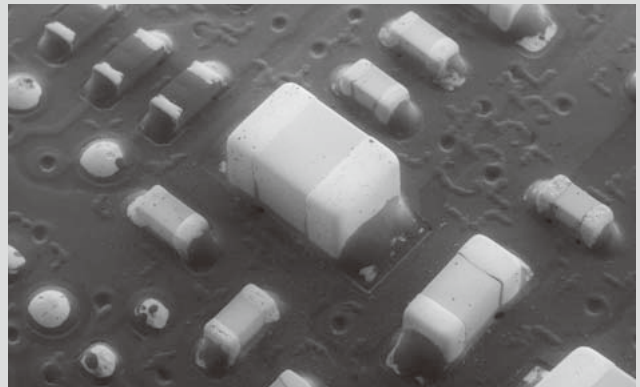

Accelerating Voltage: 15kV
Magnification: 15x

Biology/Pharmaceutical Materials

▼ Fungus

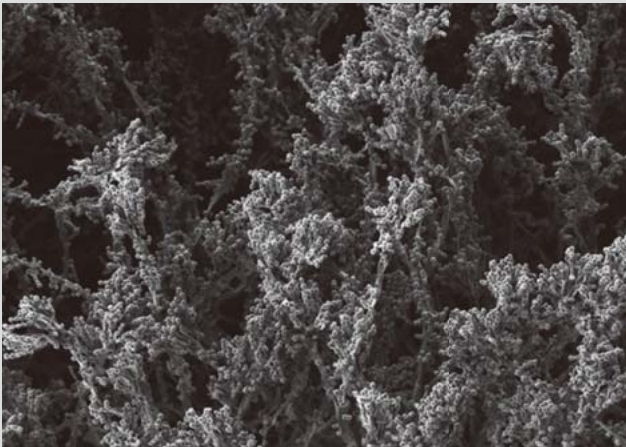

Accelerating Voltage: 4kV
Magnification: 470x

▼ Fungus

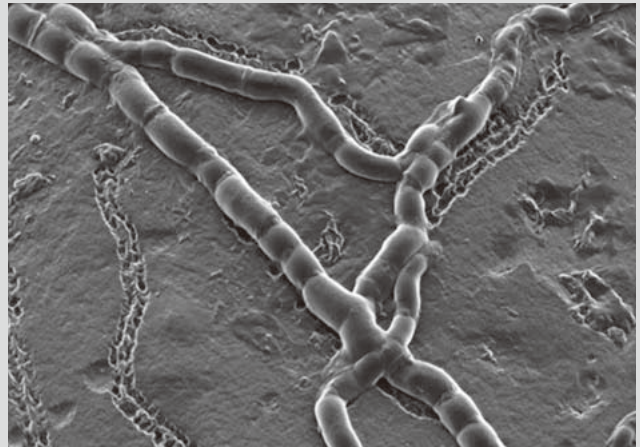

Accelerating Voltage: 1.2kV
Magnification: 5,000x

▼ Kidney section

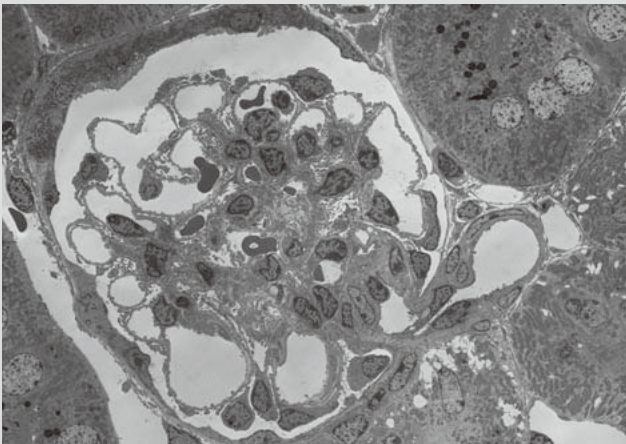

Accelerating Voltage: 30kV
Magnification: 1,300x

▼ Liver section

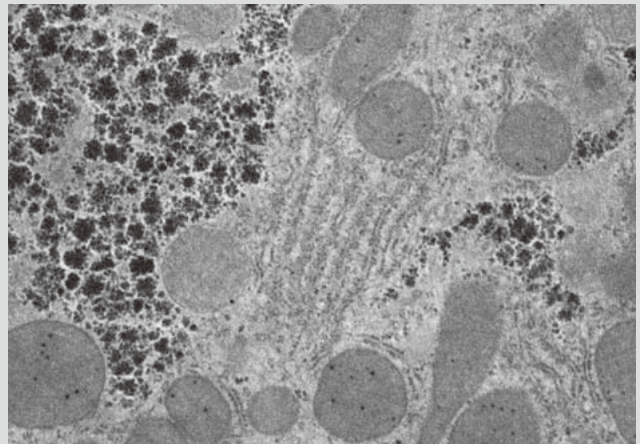

Accelerating Voltage: 30kV
Magnification: 25,000x

▼ Tablet



Accelerating Voltage: 20kV
Magnification: 7x

▼ Algae

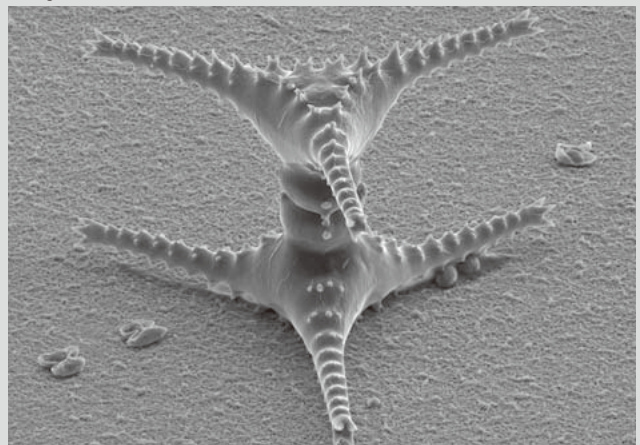

Accelerating Voltage: 8kV
Magnification: 1,300x

■SU3800



Layout Sample

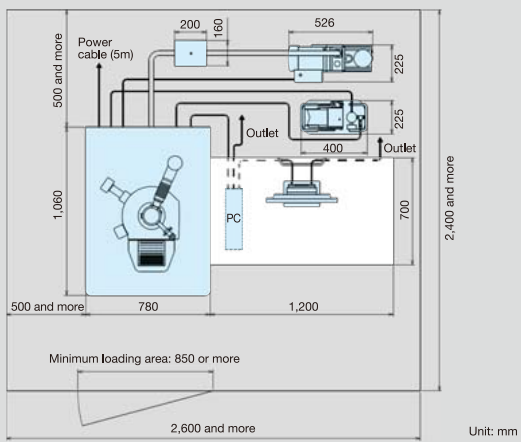

Power supply: Single-phase, AC 100-240, 50/60Hz, 1.5KVA

■SU3900



Layout Sample

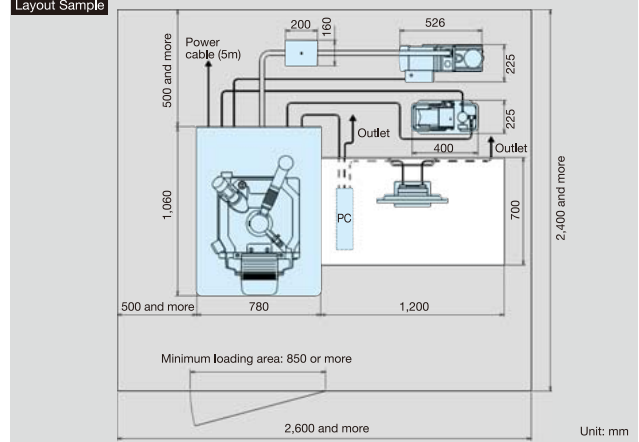

Power supply: Single-phase, AC 100-240, 50/60Hz, 1.5KVA

■SPECIFICATIONS

Items	Product Features		
	SU3800	SU3900	
Secondary Electron Resolution	3.0 nm (accelerating voltage 30 kV, WD=5 mm, high vacuum mode)		
Backscattered Electron Resolution	15.0 nm (accelerating voltage 1 kV, WD=5 mm, high vacuum mode)		
Magnification	4.0 nm (accelerating voltage 30 kV, WD=5 mm, low vacuum mode)		
Accelerating Voltage	×5 to ×300,000 (magnification of image*1)		
Low Vacuum Mode Setting	×7 to ×800,000 (magnification of actual display*2)		
Image Shift	0.3 kV to 30 kV		
Maximum Specimen Size	6 to 650 Pa		
Specimen Stage	± 50 μm (WD=10 mm)		
	X	Φ 200 mm	Φ 300 mm
	Y	0 to 100 mm	0 to 150 mm
	Z	0 to 50 mm	0 to 150 mm
	R	5 to 65 mm	5 to 85 mm
	T	360° in continuous mode	
	Maximum Movable Range	-20 to +90°	
	Maximum Movable Height	Φ 130 mm (in combination with R)	Φ 200 mm (in combination with R)
Motor Drive	80 mm (WD= 10 mm)		130 mm (WD= 10 mm)
Electron Optics	5-axis motor drive		
	Electron-Gun		Pre-centered cartridge type tungsten hairpin filament
	Objective-Lens Aperture		4-hole movable aperture
	Detectors		Secondary electron detector, sensitive semiconductor backscattered electron detector
Image Display	WD for EDX analysis		WD=10 mm (T.O.A=35°)
	Auto-Axis Alignment. Function	Beam control : auto (AFS→ABA→AFC→ABCC)	
		Optical axis adjustment: auto (current alignment)	
	Auto Image Adjustment Function	Beam brightness: auto	
		Auto brightness and contrast control (ABCC)	
		Auto focus control (AFC)	
		Auto stigma and focus (ASF)	
Auto filament saturation (AFS)			
Auto beam alignment (ABA)			
Auto start (HV-ON→ABCC→AFC)			
Operation Auxiliary Function	Raster rotation, dynamic focus, image improvement function, Data input (point-to-point measurement, angle measurement, texts), preset magnification, Stage positioning navigation function (SEM MAP), beam marking function		
Optional function	■ Hardware: Track ball, Joystick, Operation panel, Compressor, Ultra sensitive low vacuum detector (UVD), Chamber scoop, Camera navigation system ■ Software: SEM data manager, External communication interface, 3D-capture, Stage free mode, EDS integration		
Options(for External Devices)	Energy dispersive X-ray spectrometry (EDS), Length dispersive X-ray spectrometry (WDS), Various external stages (heating stage, cooling stage, tensile stage)		

1. Set magnification with 127 mm x 95 mm (4" x 5" picture size) as display size. 2. Set magnification with 509.8 mm x 286.7 mm (1,920 x 1,080 pixels) as display size.



Science for a better tomorrow

The Science Ring demonstrates our desire to contribute to the betterment of society through Hitachi's innovative scientific instruments and expertise.

* This logo is the trademark of Hitachi High-Technologies Corporation throughout the world.

Notice: For proper operation, follow the instruction manual when using the instrument.

Specifications in this catalog are subject to change with or without notice, as Hitachi High-Technologies Corporation continues to develop the latest technologies and products for our customers.

Copyright (C) Hitachi High-Technologies Corporation 2019 All rights reserved.

 **Hitachi High-Technologies Corporation**

Tokyo, Japan

<https://www.hitachi-hightech.com/global/science/>

24-14, Nishi-shimbashi, 1-chome, Minato-ku Tokyo, 105-8717, Japan

For technical consultation before purchase, please contact: contact@nst.hitachi-hitec.com